



TUFGRIP[™]

Series 2000 for PVC & PVCO Pipe
"A Proven Third Generation Mechanical Joint Restraint"



MJ TUFGrip[™] TLP

Torque Nut



TYLER UNION[®]
Quality Waterworks Products

Tyler Union's TUF Grip restraints represent the culmination of 20 years of engineering and testing. As a 3rd generation restraint, TUF Grip is the best available technology in the Waterworks market for use in restraining PVC pipe.



Designed by Harold Kennedy & Associates, Inc.

"BETTER BY DESIGN"

SPECIFICATIONS:

- Proven to restrain plain end PVC pipe in diameters 3" thru 36", PVCO pipe in diameters 4" thru 12", and HDPE Pipe 4" thru 16"
- Restraint design conforms to applicable requirements of ANSI/AWWA C111, ANSI/AWWA C153, and ANSI/AWWA C110
- Restraint engineered for securing plain end pipe to mechanical joint fittings conforming to ANSI/AWWA C110, C111, and C153
- Rated for working water pressure of 305 psi for 3"-12", 235 psi for 14"-24", 150 psi for 30", and 125 psi for 36" (**details on next page**)
- Cast of ASTM compliant 65-45-12 ductile iron complete with cast on date code and country of origin for traceability
- Restraint and all components are designed and proven for a 2:1 safety factor based on the PVC, PVCO, and HDPE pipe pressure rating **Note: Refer to the following pages for pressure rating**
- Deflection rating when installed on pipe with nominal diameter shall be 3° for 3" thru 12", 2° for 14" thru 16", and 1.5° for 18" thru 36"
- Standard coating for Non-Domestic restraint is 4-6 mil of Alkyd resin baking enamel
- Gripping wedge, wedge collar bolt and twist off torque limiting nut shall be e-coated
- FM approved for 4" thru 12" applications and UL listed and approved for 3" thru 12" applications
- Color coded red for pipe type (C900 PVC/C905 PVC/ *C909 PVCO/D2241 PVC) - ***Note: Refer to next page for C909 pipe applications**

FEATURES & ADVANTAGES:

- Torque limiting nut on gripping wedge assembly twists off within a designed torque range eliminating the need for specialized tools
- Gripping wedge assembly pivots providing stronger engagement of pipe wall at lower torque requirement (45-60 ft.-lbs.)
- Proven restraint technology utilizing fewer gripping wedges in frequently applied diameters, reducing trench time and project cost
- There is no washer or spacer to remove when installing restraints on 3" to 12" ASTM D2241 PVC pipe with IPS outside diameter
- Restraint's heavy duty construction and design eliminates the need for costly thrust blocks and tie rods
- Suitable for Potable and Wastewater applications
- Approved for use on multiple classes of pipe - **Additional pressure ratings and associated pipe classes provided on the following pages**

ISO 9001-2008 Registered	Listed with Underwriters Laboratory	Factory Mutual Approved		
Product Source/Type	Name of Project	Name of Contractor	Project Engineer	Spec. Section and/or Project No.

Tyler Union Waterworks Contact Information

Tyler: 11910 CR 492 • Tyler, Texas 75706 • (800) 527-8478
Anniston: 1501 W 17th St. • Anniston, AL 36201 • (800) 226-7601
Corona: 1001 El Camino Ave. • Corona, CA 92879 • (866) 527-8471

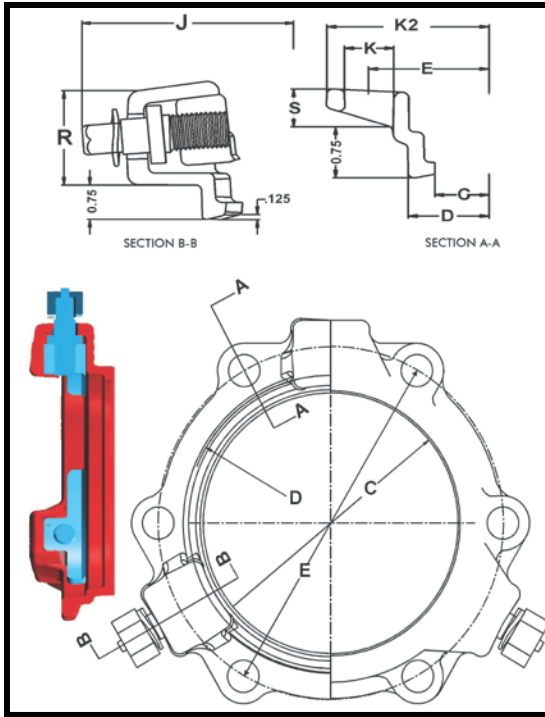

TUFGrip™ MJ Restraint Dimensions

Size (inches)	C	D	E	K2	J	K	R	S
3	4.08	4.88	6.19	7.67	9.82	3/4	2.20	0.86
4	4.93	5.92	7.50	8.98	10.67	7/8	2.20	0.73
6	7.03	8.02	9.50	10.98	12.77	7/8	2.24	0.82
8	9.18	10.17	11.75	13.23	14.92	7/8	2.28	0.82
10	11.23	12.22	14.00	15.70	16.97	7/8	2.37	0.93
12	13.33	14.32	16.25	17.95	19.07	7/8	2.40	0.93
14	15.44	16.40	18.75	20.43	21.18	7/8	2.57	0.91
16	17.54	18.50	21.00	22.88	23.28	7/8	2.57	1.05
18	19.64	20.60	23.25	25.43	25.38	7/8	2.57	1.05
20	21.74	22.70	25.50	27.50	27.48	7/8	2.66	1.15
24	25.94	26.90	30.00	32.00	31.68	7/8	2.72	1.35
30	32.18	33.30	36.88	39.42	39.78	1-1/8	3.86	1.53
36	38.48	39.60	43.75	46.29	46.08	1-1/8	3.86	1.53

SERIES 2000 TLP-PVC TUF Grip™ - APPLICATION CHART

Size (Inches)	Part No. - Gland Only Domestic / Non-Domestic	Wedge Qty.	T-Head Bolt Qty.	Bolt Size	Gland Weight(lbs.)	Weight (w/Acc.)	*Pressure Rating	Pipe O.D. (Inches)
3	CALL / 113928	2	4	5/8" x 3"	7.0	11.0	*305 / DR14	3.50
4	516002 / 113935	2	4	3/4" x 3.5"	8.3	12.2	*305 / DR14	4.50-4.80
6	516019 / 113942	3	6	3/4" x 4"	12.4	18.3	*305 / DR14	6.63-6.90
8	516026 / 113959	3	6	3/4" x 4"	14.9	20.8	*305 / DR14	8.63-9.12
10	516033 / 113973	6	8	3/4" x 4"	25.7	33.4	*305 / DR14	10.75-11.10
12	516040 / 113980	8	8	3/4" x 4"	34.1	42.0	*305 / DR14	12.75-13.20
14	516248 / 113997	10	10	3/4" x 4.5"	45.1	55.4	*235 / DR18	15.30
16	516262 / 114000	12	12	3/4" x 4.5"	56.2	68.4	*235 / DR18	17.40
18	516286 / 114017	12	12	3/4" x 4.5"	62.4	74.8	*235 / DR25	19.50
20	516309 / 114024	14	14	3/4" x 4.5"	72.9	86.9	*235 / DR25	21.60
24	516323 / 114031	16	16	3/4" x 5"	93.2	109.8	*235 / DR25	25.80
30	CALL / 461302	20	20	1" x 7.5"	251	293	*150 / DR25	32.00
36	CALL / 461357	24	24	1" x 7.5"	281	331	*125 / DR25	38.30

*Note: The pressure ratings are rated working water pressures for the restraint. See page 3 for additional ratings.

ISO 9001-2008 Registered

Listed with Underwriters Laboratory

Factory Mutual Approved

STOP-LOOK :

- Extra length T-Head bolts are provided with 30" - 36" restraints to facilitate mechanical joint assembly per AWWA C600
- For UL/FM Approvals, 3" - 12" were tested to 755 psi, 14" - 16" were tested to 755 psi and 18" - 24" inch were tested to 535 psi
- TUF Grip 30-36 inch provided with TRU-Lock™ mechanical joint gasket to ensure pressure rating and safety factors are met
- Mechanical joint T-head bolt torques for C909 applications are as provided; *55-65 ft.-lbs for 4" to 8" and *65 to 75 ft.-lbs. for 10" to 12" assembly. You must specify restraints are for C909 PVCO pipe upon order placement. Call for availability
- Installation and hydrostatic testing shall be in accordance with AWWA C600 and AWWA C651
- TUF Grip 4" to 24" restraints shall meet the requirements of ASTM F1674, current revision
- **Caution:** Pressure testing of piping systems restrained or un-restrained with insufficient backfill or bracing is not recommended

Tyler Union Waterworks Contact Information

Tyler: 11910 CR 492 • Tyler, Texas 75706 • (800) 527-8478

Anniston: 1501 W 17th St. • Anniston, AL 36201 • (800) 226-7601

Corona: 1001 El Camino Ave. • Corona, CA 92879 • (866) 527-8471

**ADDITIONAL SERIES 2000 TLP-TUF GRIP™ RESTRAINT RATINGS														
	AWWA C900			AWWA C905			ASTM D2241			HDPE* AWWA C906				
SIZE (Inches)	DR14	DR18	DR25	DR18	DR25	DR32.5	SDR17	SDR21	SDR26	DR7.3	DR9	DR11	DR13.5	DR17
3	-	-	-	-	-	-	250	200	160	254	200	160	128	100
4	305	235	165	-	-	-	250	200	160	254	200	160	128	100
6	305	235	165	-	-	-	250	200	160	254	200	160	128	100
8	305	235	165	-	-	-	250	200	160	254	200	160	128	100
10	305	235	165	-	-	-	250	200	160	254	200	160	128	100
12	305	235	165	-	-	-	250	200	-	254	200	160	128	100
14	-	-	-	235	165	125	-	-	-	254	200	160	128	100
16	-	-	-	235	165	125	-	-	-	254	200	160	128	100
18	-	-	-	200	165	-	-	-	-	-	-	-	-	-
20	-	-	-	200	165	-	-	-	-	-	-	-	-	-
24	-	-	-	165	165	125	-	-	-	-	-	-	-	-
30	-	-	-	-	165	125	-	-	-	-	-	-	-	-
36	-	-	-	-	125	125	-	-	-	-	-	-	-	-

****Note: Pressure Ratings for Ordinary Water Works Restraint Application with Transitory Surges Only**

****Note: AWWA C909 PVC0 Restraint Pressure Rating is per the Pressure Rating Listed on the Pipe**

*** Note: HDPE application require a separate stiffener ring. 4-16 for DI OD Pipe and 4-12 for IPS Pipe**

Assembly steps for (3"-12" ASTM D2241 IPS PVC), (4"-12" AWWA C909 PVC0), and (4"-36" AWWAC900/C905 PVC)

Steps: 1 and 2

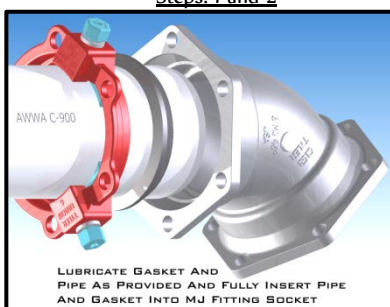

Step: 3

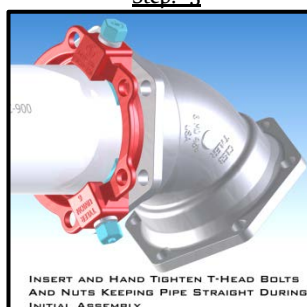

Steps: 4 and 5

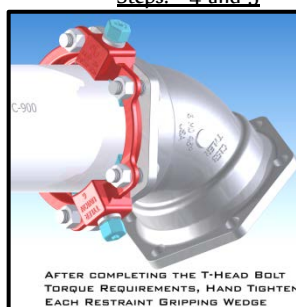

Steps: 6 and 7

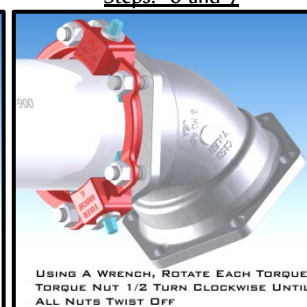

1. Insure the beveled pipe end to be joined and mechanical joint socket are clean and free of debris. Slide the RED TUF Grip onto the beveled end of the pipe to be restrained. The TUF Grip compression lip extension must be toward the beveled end of the pipe being restrained.
2. Evenly lubricate the beveled pipe end, exterior pipe wall, and inside surface of the gasket with a lubricant that meets the requirements of AWWA C111. Now place the **MJ gasket over the plain beveled end of the pipe with the narrow edge of the tapered gasket toward the pipe end. ****NOTE:** Use MJ transition gasket with IPS diameter pipe.
3. Fully insert the beveled pipe end into the MJ socket pipe landing. Keeping the pipe straight in the MJ socket, slide/push the MJ gasket firmly and evenly into the MJ socket recess. Joint must be kept straight during assembly.
4. Push the TUF Grip compression lip extension evenly against the thick side of the MJ gasket and insert all T-Head bolts with nuts. Use only T-Head bolts and nuts that meet AWWA C111 requirements. With the TUF Grip restraint lip extension against the MJ gasket, evenly hand-tighten the nuts on the T--Head bolts making sure the restraint body is centered on the pipe and within in the MJ socket. If joint deflection is needed, deflect the pipe only after hand tightening of all nuts is completed. Joint deflection is 3° max for 3", 5° max for 4"-12", 2° max for 14"-16", 1.5° max for 18"-36". **NOTE:** Maximum deflection values provided apply with nominal pipe, fitting, and restraint diameters.
5. Using a wrench, tighten the T-Head bolts and nuts a few turns at a time in an alternating or star pattern. Maintain equal spacing or distance between the TUF Grip bolt flange and the MJ socket bolt flange as the MJ gasket is compressed. Repeat the process in an alternating pattern for all T-Head bolts and nuts. The T-Head bolt and nut torque requirement for restraints is 3"- 45-60 ft.-lbs., 4"- 24"-75-90 ft.-lbs., and 30"- 36"- 100-120 ft.-lbs.
NOTE: The C909 PVC0 T-Head bolt and nut torque is 55-65 ft.-lbs. for 4"-8" and 65-75 ft.-lbs. for 10"-12"restraints.
DO NOT OVER-TORQUE T-HEAD BOLTS and NUTS WHEN ASSEMBLING PVC and PVC0 PIPE!
6. ****Hand-tighten** the torque limiting nuts attached to the TUF Grip wedge assemblies in a clockwise direction with an alternating or star pattern until all gripping wedges are in contact with the pipe wall. Rotational direction of torque nut is indicated by recessed arrow on the face of the nut. With a wrench (box, socket, or pneumatic), continue to tighten each torque nut ½ turn in an alternating or star pattern around the restraint until all torque limiting nuts twist off. **NEVER** turn a torque limiting nut more than ½ turn without turning the remaining torque nuts an equal amount! ****NOTE:** For IPS and PVC0 applications, ensure step 5 is completed before engaging wedges. Failure to comply will result in excessive pipe wall deflection and torque nuts will not twist off as designed.
7. When all torque limiting nuts twist off, the mechanical joint and restraint assembly are complete.

Tyler Union Waterworks Contact Information

Tyler: 11910 CR 492 • Tyler, Texas 75706 • (800) 527-8478
Anniston: 1501 W 17th St. • Anniston, AL 36201 • (800) 226-7601
Corona: 1001 El Camino Ave. • Corona, CA 92879 • (866) 527-8471

www.tylerunion.com